

MODEL: SLO264
ASSEMBLY INSTRUCTIONS
READ AND SAVE THESE INSTRUCTIONS

UNPACK THE FOUNTAIN

YOU SHOULD HAVE RECEIVED BELOW PARTS:

- 1X BOY & DOG FOUNTAIN,
- 1X PUMP WITH 5M CABLE,
- 1X LED LIGHT WITH 5M CABLE,
- 1X SOLAR PANEL,
- 1X BRACKET,
- 1X TUBE,
- 1X GROUND SPIKE.

TO PROTECT THE FINISH, PLACE ALL PARTS ON A SOFT SURFACE.

FOUNTAIN ASSEMBLY

1. LOCATE THE HOSE FROM THE REAR ACCESS PANEL OF THE FOUNTAIN. CONNECT THE PUMP TO THE HOSE, PUMP CABLE EXITS OUT FROM REAR ACCESS PANEL, READY FOR CONNECTION TO THE SOLAR PANEL. THE LED LIGHT RING CAN BE PLACED IN THE RESERVOIR, THE LIGHT CABLE SHOULD FEED THROUGH THE CABLE HOLE IN THE RESERVOIR AND EXITS OUT FROM REAR ACCESS PANEL, READY FOR CONNECTION TO THE SOLAR PANEL.

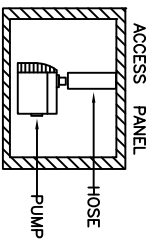
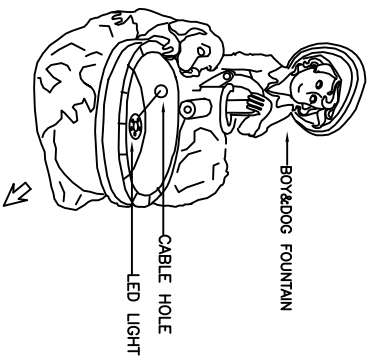

2. IDENTIFY A SUITABLE GROUND AREA WHERE YOUR FOUNTAIN CAN BE PLACED. MAKE SURE THE GROUND IS LEVEL AND FREE OF LARGE STONES.

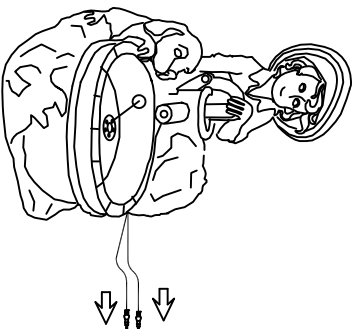

3. FILL THE RESERVOIR WITH APPROPRIATE AMOUNT OF WATER TO COMPLETELY SUBMERSE THE PUMP.

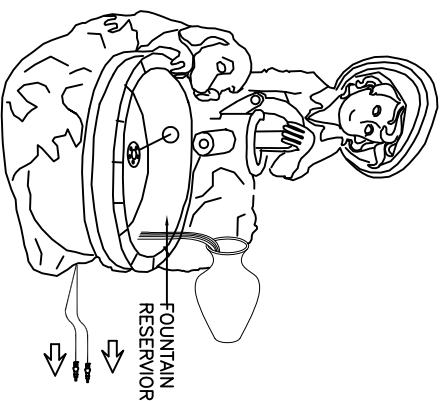

MODEL: SLO264
ASSEMBLY INSTRUCTIONS
READ AND SAVE THESE INSTRUCTIONS

SOLAR PUMP ASSEMBLY

4. JOIN BRACKET, TUBE AND SPIKE TOGETHER, THEN ATTACH BRACKET TO BACK OF THE SOLAR PANEL AS SHOWN.

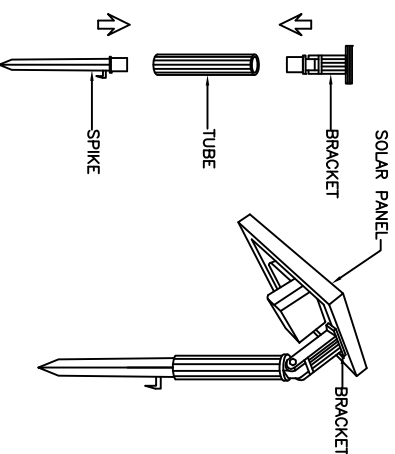

5. INSERT THE SPIKE INTO THE GROUND. POSITION THE SOLAR PANEL TO FACE SOUTH (In Northern Hemisphere) AS MUCH AS POSSIBLE TO MAKE THE MOST OF THE DAYLIGHT HOURS. IT IS IMPORTANT TO ANGLE THE SOLAR PANEL TO FACE SUN WHEN SUN IS AT ITS HIGHEST POINT. ENSURE THE SOLAR PANEL IS NOT SHADED BY TREES, SHRUBS OR BUILDINGS

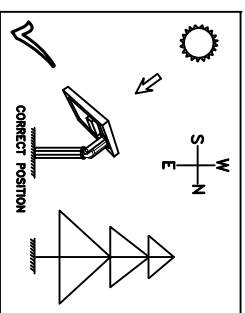

6. CONNECT THE PUMP, LED LIGHT WITH THE SOLAR PANEL (CHARGER SOLD SEPARATELY).

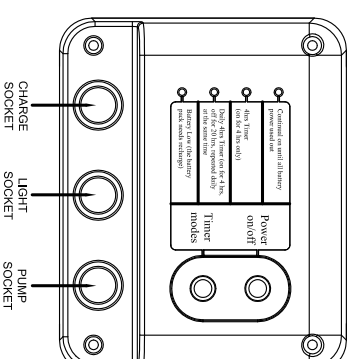
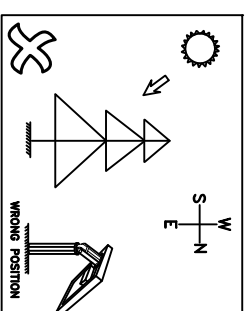

7. NOW YOUR NEW FOUNTAIN IS ASSEMBLED READY FOR USE.

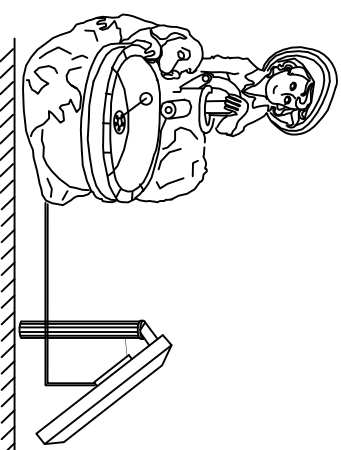

MODEL: SLO264
OPERATING INSTRUCTIONS
READ AND SAVE THESE INSTRUCTIONS

8. OPERATION

NOTE: THE LED LIGHT IS DESIGNED TO WORK AT NIGHT TIME ONLY.

Continued on Model: Press [Power on/off] button, the top indicator light [Continued on] will be on – the pump will run continuously until the battery runs out of all power. The pump will automatically restart up when the battery is recharged under good enough sun light.

4hrs Timer Mode: Press [Timer modes] button repeatedly until the second indicator light [4hrs Timer] lit – the pump will run for 4 hours and stop. The pump will not start up again by itself until you re-open it manually.

Daily 4hrs Timer Mode: Press [Timer modes] button repeatedly until the third indicator light [Daily 4hrs Timer] lit – the pump will run for 4 hours and shut down (in standby) for 20 hours, and this timing set will be repeated daily at the same time. You can reset the pump's daily start up time by switching on it at a new desired time at this mode. **NOTE:** The third indicator light will be blinking slowly when the pump runs out of 4 hours time and be in standby in daytime. In order to save the battery power, the indicator light will be off after day goes dark but you can activate the indicator light and check its status with a single push of either button, the indicator light will be on for a while and shut off again.

[Battery Low] Red Indicator Light Blinking On – That means the battery power is low, the pump will stop shortly for protecting the battery. The red indicator light will be off after the solar panel receives good sun light and the battery has been recharged.

PLEASE NOTE THAT: ONLY THE ORIGINAL BATTERY CHARGER (SOLD SEPARATELY) SHOULD BE USED AS OTHER ALTERNATIVES MAY DAMAGE THE BATTERY AND WILL VOID THE GUARANTEE.

9. PERFORMANCE OF PUMP

THE PERFORMANCE OF THE PUMP DEPENDS ON THE ORIENTATION OF THE SOLAR PANEL TOWARD THE SUN AND THE SUNLIGHT STRENGTH. THE MAX DATA OBTAINED UNDER OPTIMAL CONDITIONS. A SOLAR PANEL POSITIONED IN THE SHADE OR IN POOR WEATHER CAN NOT BE GUARANTEED. FOR THIS MODEL WITH BATTERY, THE PERFORMANCE OF THE PUMP ALSO DEPEND ON BATTERY POWER LEVEL, PUMP CAN NOT WORK IF BATTERY POWER IS LOW.

10. MAINTENANCE OF PUMP

IF YOU FIND THE PUMP START LOSING POWER OR STOP WORKING, PLEASE CLEAN THE PUMP FILTER AND IMPELLER WITH CLEAN WATER.

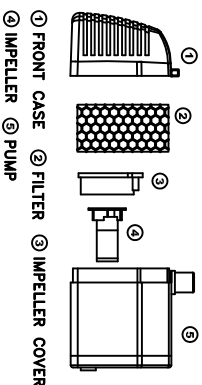

1. BATTERY INFORMATION

RECHARGEABLE BATTERY BECOMES LESS EFFICIENT WITH REPEATED CHARGE AND DISCHARGE CYCLES. THE CAPACITY OF THE BATTERY MAY ALSO REDUCE OVER TIME AND YOU MAY NOT ACHIEVE THE FULL HOURS OPERATION. IF YOU FIND THAT THE BATTERY APPEAR LESS EFFICIENT TRY TO BOOST CHARGE IT. TO DO THIS LEAVE OFF FOR 1 TO 2 SUNNY DAYS TO ALLOW THE MAXIMUM CHARGE TO THE BATTERY. WE SUGGEST TO DO THIS OCCASIONALLY TO HELP PROLONG BATTERY LIFE. IF AFTER THIS BOOST CHARGE YOUR BATTERY STILL DOES NOT PERFORM TO EXPECTATIONS, YOU SHOULD REPLACE IT WITH NEW BATTERY.

1.2. BATTERY REPLACEMENT

THIS SOLAR PUMP HAS BEEN DESIGNED TO RUN MANY YEARS IF CORRECTLY MAINTAINED. THE LI-ION BACKUP BATTERY PACK, IN COMMON WITH ALL RECHARGEABLE BATTERIES, HAS A LIMITED LIFE SPAN, YOU MAY NEED TO REPLACE IT AFTER 18 MONTHS ~ 24 MONTHS USE.

13.1 REMOVE THE 4PC SCREWS (PART 1) FROM THE CONTROL PANEL COVER (PART 2)

13.2 DISCONNECT THE BATTERY PACK CONNECTOR (PART 3), THEN REMOVE THE BATTERY PACK (PART 4) FROM CONTROL PANEL BASE (PART 5)

13.3 REPEAT STEP 1 AND 2 IN REVERSE ORDER TO REASSEMBLE.

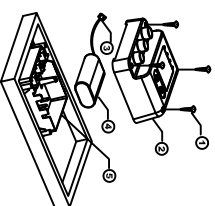

MODEL: SLO264
OPERATING INSTRUCTIONS
READ AND SAVE THESE INSTRUCTIONS

TOOLS NEEDED:
SMALL SIZED PHILIPS HEAD SCREWDRIVER.

DISPOSE OF OLD BATTERY PACK ACCORDING TO THE LOCAL REGULATIONS, RECYCLE WHEN POSSIBLE.

IMPORTANT!
ONLY ORIGINAL BATTERY PACK SHOULD BE USED FOR REPLACEMENT AS OTHER ALTERNATIVES MAY BE INCOMPATIBLE, MAY DAMAGE THE SYSTEM EVEN CAUSE RISK AND WILL VOID THE GUARANTEE.

1.3. PROBLEM SHOOTING

CHECK SOLAR PANEL, PUMP, LED LIGHT CONNECTED WELL.

CHECK SOLAR PANEL CORRECTLY POSITIONED IN SUNNY PLACE, ENSURE THE SOLAR PANEL IS NOT SHADED BY TREES, SHRUBS OR BUILDINGS.

CHECK IF [Battery Low] RED LIGHT IS BLINKING, IF SO, THAT MEANS THE BATTERY PACK IS LOW POWER. SWITCH OFF THE PUMP AND LEAVE SOLAR PANEL CHARGING UNDER GOOD DIRECT SUNLIGHT FOR AT LEAST 6 HOURS.

CHECK WATER LEVEL, MAKE SURE THE PUMP IS FULLY SUBMERGED.

CHECK THE FOUNTAIN TUBING FOR KINKS AND OBSTRUCTIONS.

CHECK THE PUMP IMPELLER BLOCKED BY DEBRIS

CHECK THE PUMP MAY BE "AIR LOCKED", TURN ON/OFF THE PUMP SEVERAL TIMES TO CLEAR ANY AIR THAT MAY HAVE BEEN TRAPPED.

1.4. TECHNICAL DATE

MAX. PUMP WATER FLOW: 250LPH
MAX. PUMP WATER LIFT: 90CM
PUMP WORKING VOLTAGE: DC8.4V~DC6.5V
PUMP WORKING POWER: 1.2W~0.6W
PROTECTION GRADE OF PUMP: IP68
SOLAR PANEL: 2W-9V-0.222A
SOLAR PANEL SIZE: 213X202X20MM
PROTECTION GRADE OF PANEL: IP44

LI-ION BATTERY PACK: 7.4V/1.2AH
PROTECTION GRADE OF BATTERY BOX: IP44
LED LIGHT WORKING VOLTAGE: DC7.4V
LED LIGHT WORKING POWER: 0.15W
PROTECTION GRADE OF LED LIGHT: IP68

1.5. WINTER PROTECT

INDOOR STORAGE IS RECOMMENDED IN WINTER. THE NORMAL OPERATING AMBIENT TEMPERATURE FOR LITHIUM BATTERY IS 10°C TO 45°, DO NOT USE THE PRODUCT BEYOND THIS TEMPERATURE RANGE.

IMPORTANT!!!

IN ORDER TO KEEP THE BATTERY HEALTHY DURING WINTER STORAGE PLEASE MAKE SURE THE BATTERY IS RE-CHARGED BEFORE WINTER STORAGE. IN ORDER TO DO THIS, YOU CAN TURN OFF THE PUMP AND LEAVE THE BATTERY CHARGING BY THE SOLAR PANEL FOR 1 OR 2 SUNNY DAYS.

1.6. WARRANTY

THANK YOU FOR CHOOSING SUNNYDAZE DÉCOR. IF YOU HAVE ANY QUESTIONS, COMMENTS OR CONCERNS PLEASE FEEL FREE TO CONTACT US BY PHONE AT: 888-881-4688. BY EMAIL: CUSTOMERSERVICE@SERENITYHEALTH.COM, OR YOU COULD ALSO EMAIL US VIA OUR CONTACT US PAGE AT: WWW.SERENITYHEALTH.COM/CONTACT-US.

WE STAND BEHIND OUR BRAND AND THE QUALITY OF THE ITEMS WE SELL. WE WILL SEND NEW PARTS OR REPLACE PRODUCTS AT OUR DISCRETION WITHIN THE ONE YEAR WARRANTY PERIOD. BEFORE WE CAN HELP, YOU WILL NEED TO PROVIDE PROOF OF PURCHASE WITH THE DATE OF PURCHASE AND PHOTOS OF THE DEFECTIVE MERCHANDISE. WE WILL USE THE PHOTOS TO DETERMINE THE CAUSE OF DEFECT AND FOR FUTURE QUALITY CONTROL.

