

# ASSEMBLY INSTRUCTIONS

## HOCKEY TABLE ASSEMBLY

WARNING: TWO ADULTS NEEDED ASSEMBLE POOL TABLE





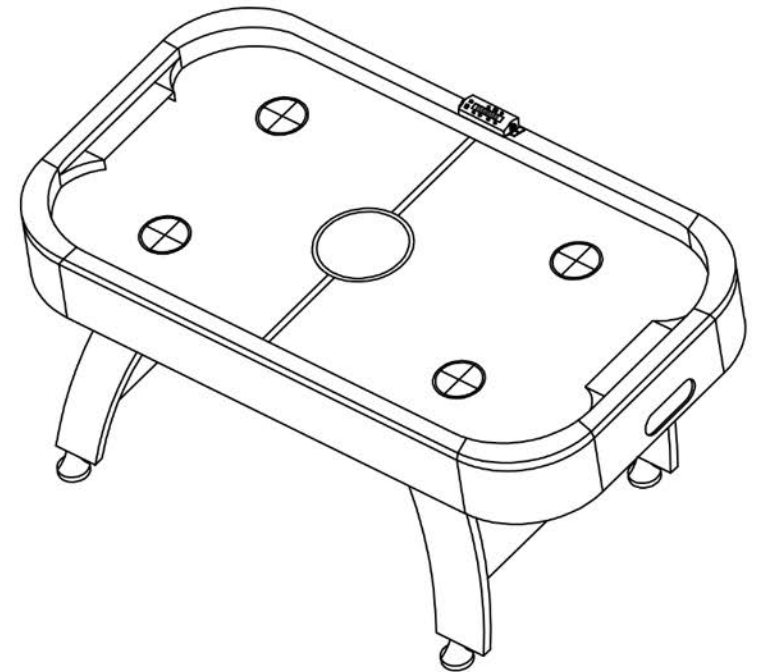
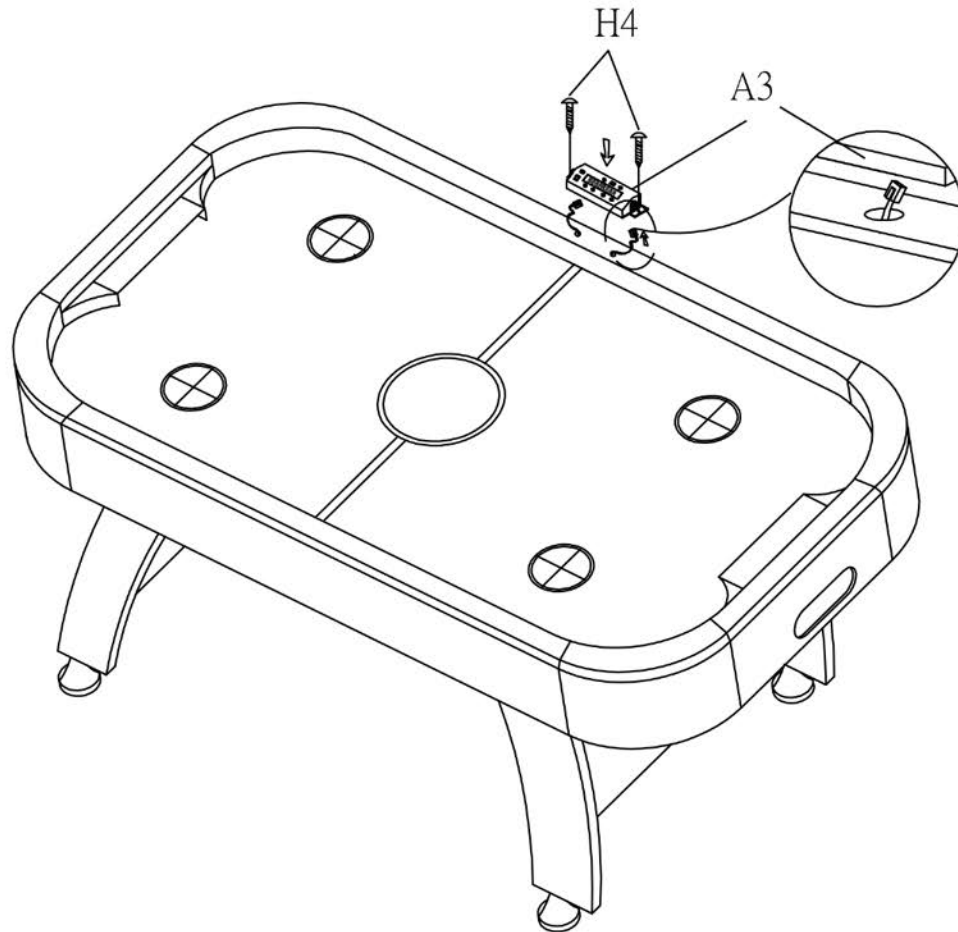







7' Air Hockey Table  
Assembly Instructions

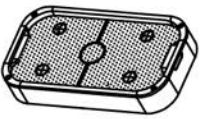

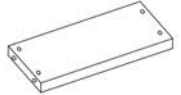
Thank you for choosing Sunnydaze Décor. If you have any questions, comments or concerns please feel free to contact us by phone at: **888-881-4668**, by email: [customerservice@serenityhealth.com](mailto:customerservice@serenityhealth.com), or you could also email us via our contact us page at: [www.SerenityHealth.com/contact-us/](http://www.SerenityHealth.com/contact-us/).

We stand behind our brand and the quality of the items we sell. We will send new parts, or replace products at our discretion within the one year warranty period. Before we can help, you will need to provide proof of purchase with the date of purchase and photos of the defective merchandise. We will use the photos to determine the cause of defect and for future quality control.

# PARTS IDENTIFIER

<p><b>A1</b></p>  <p>PUSHER 2PCS</p>	<p><b>A2</b></p>  <p>PUCK 2PCS</p>	<p><b>A3</b></p>  <p>ELECTRONIC SCORER 1 SET</p>
<p><b>P1</b></p>  <p>MAIN CABINET 1PC</p>	<p><b>P2</b></p>  <p>LEG 4 PCS</p>	<p><b>P3</b></p>  <p>LEG END PANEL 2PCS</p>
<p><b>P4</b></p>  <p>LEG LEVELER 4PCS</p>		
<p><b>H1</b></p>  <p>5/16"* 2" BOLT 12PCS</p>	<p><b>H2</b></p>  <p>5/16" FLAT WASHER 12PCS</p>	<p><b>H3</b></p>  <p>T4*62mm Screws 8PCS</p>
<p><b>H4</b></p>  <p>T4*15mm Screws 2PCS</p>	<p><b>H5</b></p>  <p>ALLEN KEY TOOL 1PC</p>	

# ASSEMBLY INSTRUCTIONS

## HOCKEY TABLE ASSEMBLY

WARNING: TWO ADULTS NEEDED ASSEMBLE POOL TABLE

